

2.46葉片

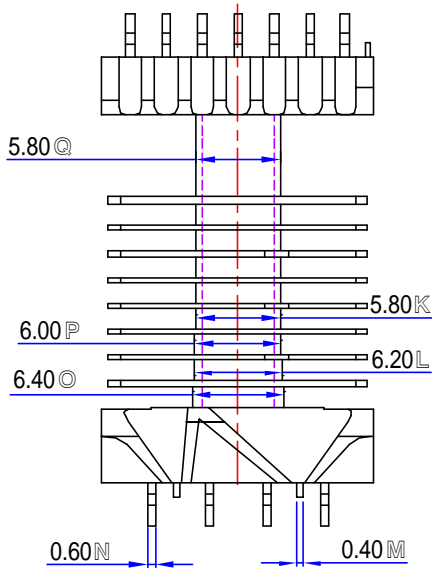

1.35.7葉片

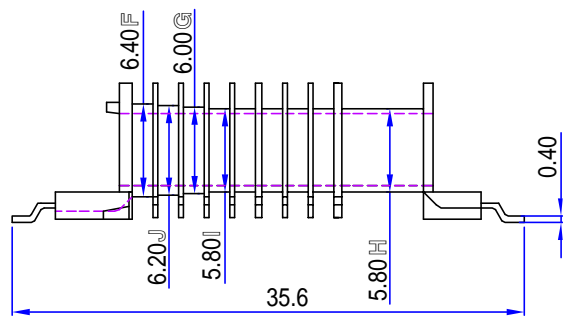
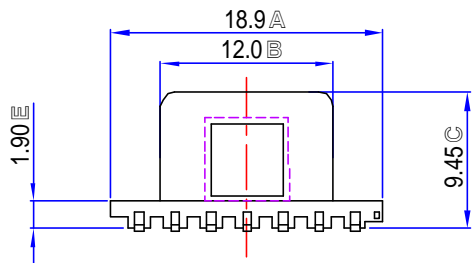
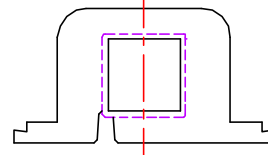
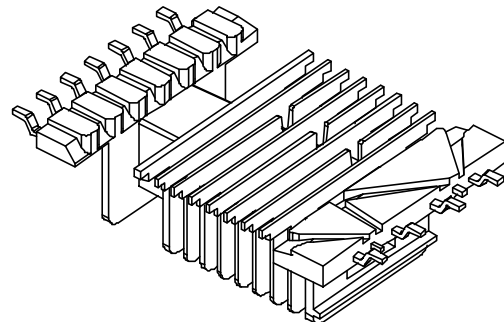
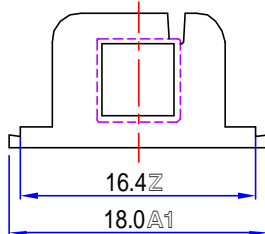

8葉片

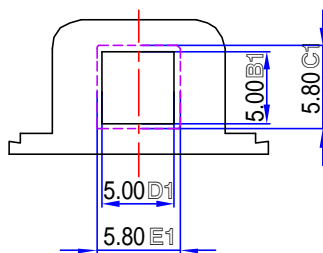

REVISIONS				
ISSUE	SYM	DATE	DRAFTER	CHECKER

NOTE:



樹林企業股份有限公司

TAIWAN SHULIN ENTERPRISE CO., LTD

WEB:www.bobbin.com.tw

e-mail:shulin@bobbin.com.tw

(TAIWAN TAIPEI) TEL: (886)(02)2225-1278 FAX: (886)(02)2222-4646

(CHINA DONGGUAN) TEL: (86)769-7730-785 FAX: (86)769-7312-387

(CHINA SUZHOU) TEL: (86)512-6621-0580 FAX: (86)512-5621-0685

MODEL

SMD-EEL-19-010

MATERIAL

L.C.P

UL RATING

UL 94V-0

PIN MATERIAL

PHOS.B

EDITION

1.0

DATE

2003/7/2

SCALE

1.5/1

TOLERANCE

.X ±0.2

.XX ±0.1

.XXX ±0.05

PIN PITCH ±0.1

UNIT

MM